

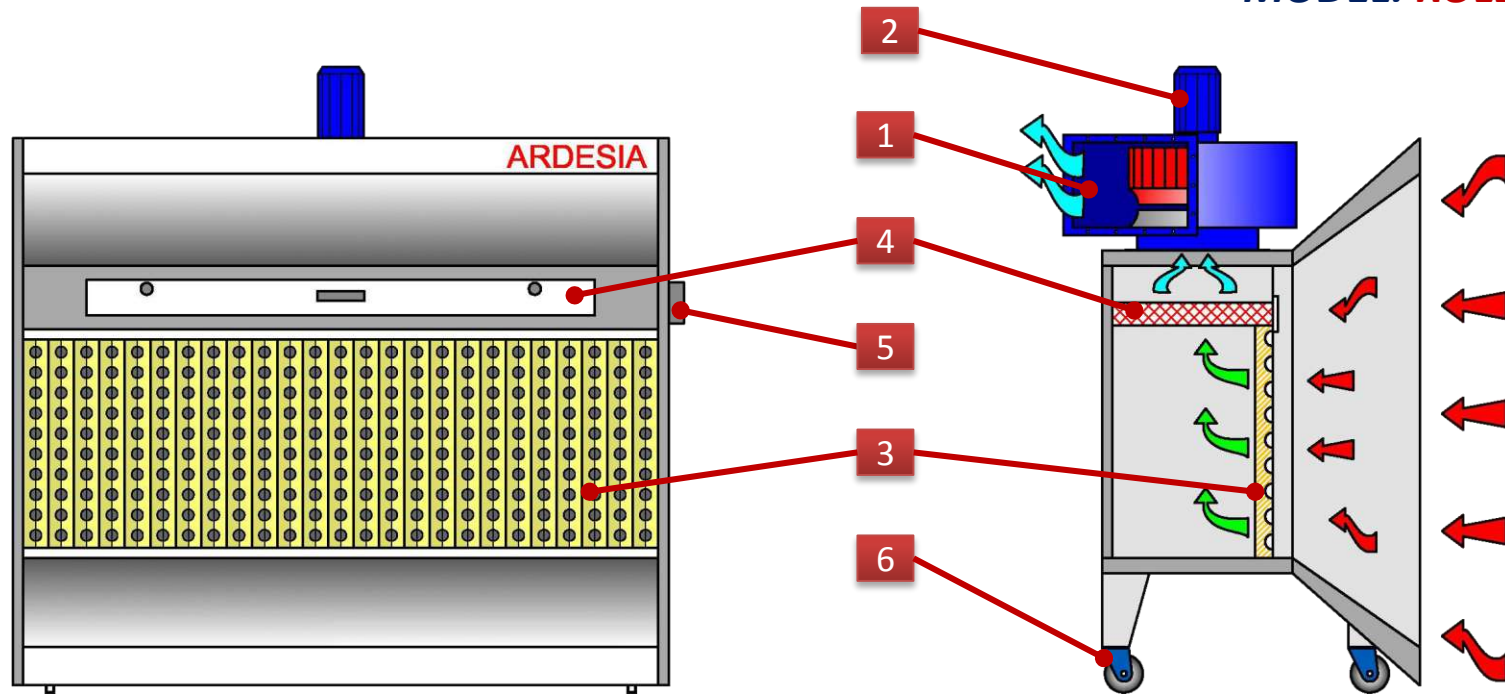

**ACTIVE SOLUTIONS BETWEEN  
INDUSTRY AND AMBIENT**

**ARDESIA SRL** via Prato delle valli 58, 47892 – Aquaviva, Repubblica di San Marino  
Tel: +378.0549 999403 Fax: +39.0541 1811003 info@ardesiasrl.net [www.ardesiasrl.net](http://www.ardesiasrl.net)  
The content of this brochure is for illustration and advertising. Ardesia Srl reserves the right to make any necessary change to improve the products.

## MODEL: ROLLER PLUS



### DESCRIPTION:

This type of painting booth is suitable for suctioning and demolishing the pigments and fumes emitted from paint-spray made with synthetic solvents, organic and water. It is built with modular panels of galvanized press-folded sheet-iron. The main features of these booths are their small dimensions and the possibility of easy transfer. This booth utilizes a suctioning wall of cardboard inertial and a second filtration with "Paint-Stop" filter drawers.

### EQUIPMENT:

1. Antispark centrifugal electrical fan
2. Energy-saving electric motor IE2
3. Frontal cardboard inertial filters
4. Metallic drawers with "Paint-Stop" filter
5. Wired electrical panel IP 55
6. Wheels
7. Change section

### CARDBOARD INERTIAL FILTER

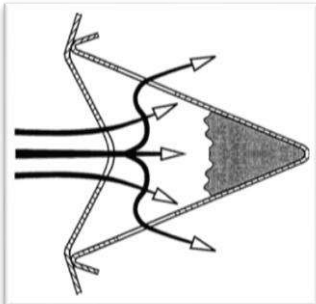
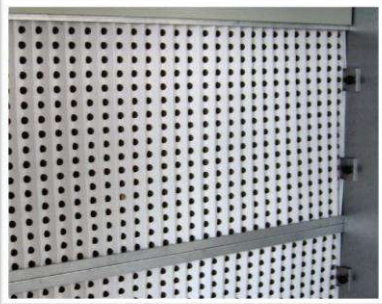

The cardboard filter uses the principle of inertial separation.

The flow of air, filled with particles to be eliminated, undergoes many and continuous changes of direction. The particles of paint, heavier than the air, are deposited in the bags of the filter, that will saturate only when these bags are completely filled with paint.

The inertial filters have self cleaning holes allowing the passage of large volumes of air with low pressure drop and to control the flow of air.

#### TECHNICAL CHARACTERISTICS :

Crossing speed, m/sec . . . . .	0,3-0,75
Thickness, mm . . . . .	65
Filter height, mm . . . . .	900
Initial pressure drop, Pa . . . . .	.30
Maximal operating temperature, °C . . . . .	180
Arresting gravametric average, % . . . . .	90 – 98
Classification(EN 779) . . . . .	G4
Flame(U.L.2-697A) . . . . .	.2

### “PAINT-STOP” FILTER IN METALLIC DRAWERS

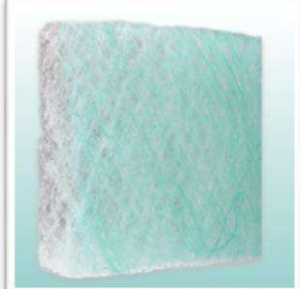
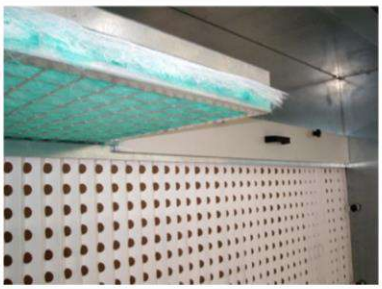

The filter “Paint Stop” is built with long fibers of glass, finished with synthetic resins and distributed with gradual density in the direction of the air flow. It has good resistance to high temperature and strong capacity of accumulation of dust, it is especially suitable for the collection of surplus paint (over-spray). It is used in metal frames.

#### TECHNICAL CHARACTERISTICS :

Product density, gr/m2 . . . . .	250
Thickness, mm . . . . .	50
Initial pressure drop, Pa . . . . .	.30
Maximal operating temperature, °C . . . . .	120
Arresting gravametric average, % . . . . .	87
Classification (EN 779) . . . . .	G3
Flame(DIN 53438). . . . .	F1

### ACTIVATED CARBON FILTERS IN METALLIC DRAWERS (Optional)

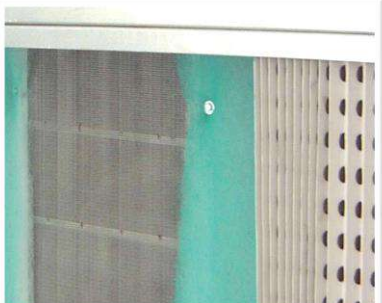

Cells with activated carbon are used to absorb pollutants and volatiles elements and smell present in the air to be treated. The frame is made of galvanized sheet with stretched galvanized net sheet containing activated carbon in the cylinders. They have a very extensive internal surface which gives the product a power of very high absorption over a large variety of substances.

#### TECHNICAL CHARACTERISTICS :

Drawer dimensions, mm. . . . .	.1620 x 500
Drawer thickness, mm . . . . .	40
Drawer capacity, kg . . . . .	20
Cylinder diameter, mm . . . . .	.3,8
Density, kg/m3 . . . . .	.550
Bagging humidity, % . . . . .	.2
Air speed, m/sec . . . . .	0,3-0,4
Pressure drop, kpas/m . . . . .	.1,5 – 2,1



# MODEL: ROLLER PLUS

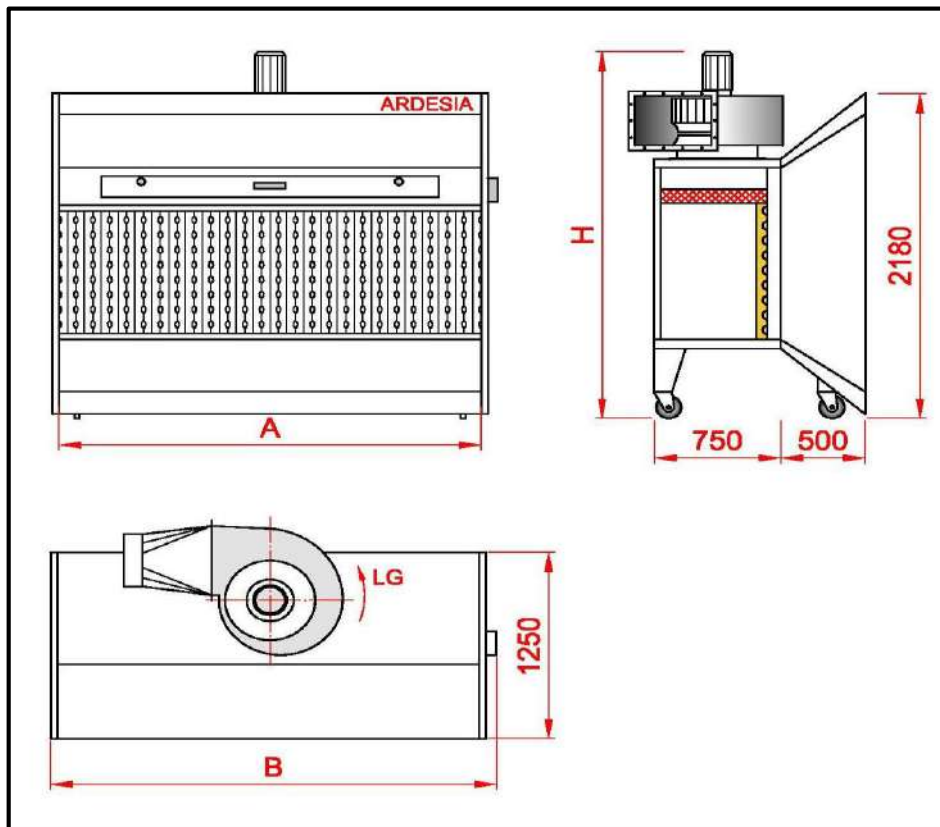

Model	A Usable width, mm	B Overall width, mm	H Overall height, mm	Diameter outbound tube, mm	Exhaust fan, power, kW	Nominal air flow m <sup>3</sup> /h
ROLLER PLUS - 1.5	1500	1600	1900	300	0,75	3000
ROLLER PLUS - 2	2000	2100	2100	300	1,1	5000
ROLLER PLUS - 2.5	2500	2600	2100	350	1,5	8000
ROLLER PLUS - 3	3000	3100	2200	350	2,2	11000